





HALOS ACOUSTIC

Novalux presenta la soluzione ideale per integrare comfort acustico e soluzioni illuminotecniche. I pannelli fonoassorbenti del nuovo HALOS ACOUSTIC contribuiscono ad aumentare il benessere generale di chi lavora e vive gli ambienti; allo stesso tempo arredano con carattere, grazie alle finiture materiche effetto cemento, nero grafite e grigio iron.

Novalux presents the ideal solution to integrate acoustic comfort and lighting solutions. The sound-absorbing panels of the new HALOS ACOUSTIC contribute to increasing the general well-being of those who work and live in the same environments; at the same time they decorate with personality thanks to the textured finishes resembling concrete, in graphite black and iron grey.

HALOS ACOUSTIC

- **MASSIMA INTEGRAZIONE TRA COMFORT ACUSTICO E SOLUZIONE ILLUMINOTECNICA**
THE BEST INTEGRATION BETWEEN ACOUSTIC COMFORT AND LIGHTING SOLUTION



- **FINITURA PANNELLI FONOASSORBENTI: NERO GRAFITE E GRIGIO IRON**
FINISHING OF SOUND-ABSORBING PANELS: GRAPHITE BLACK AND IRON GREY

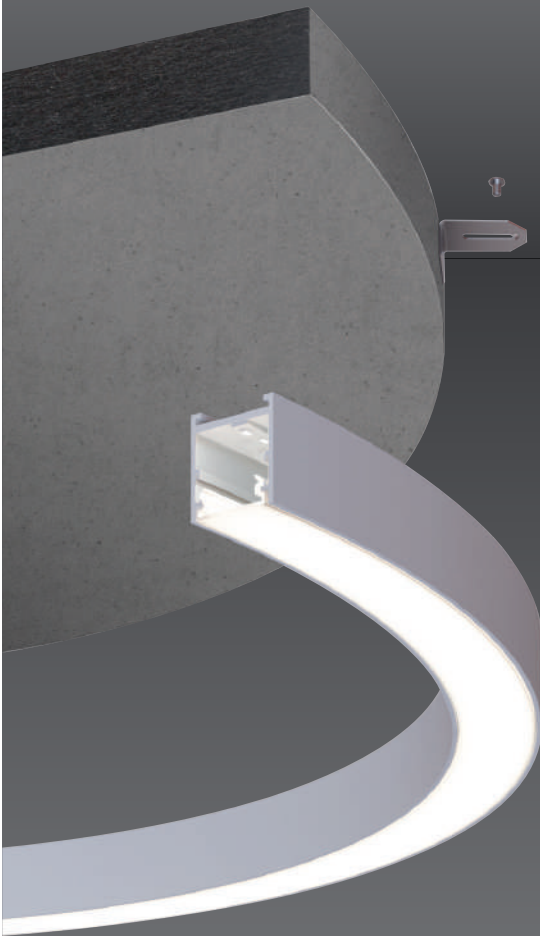

ASSORBIMENTO ACUSTICO

Il coefficiente di assorbimento acustico (α) rappresenta la frazione di energia sonora assorbita dal pannello (spessore 3 cm), espresso in funzione della frequenza F(Hz).

SOUND ABSORPTION

The sound absorption coefficient (α) represents the fraction of sound energy absorbed from the panel (thickness 3 cm), expressed as a function of frequency F(Hz).

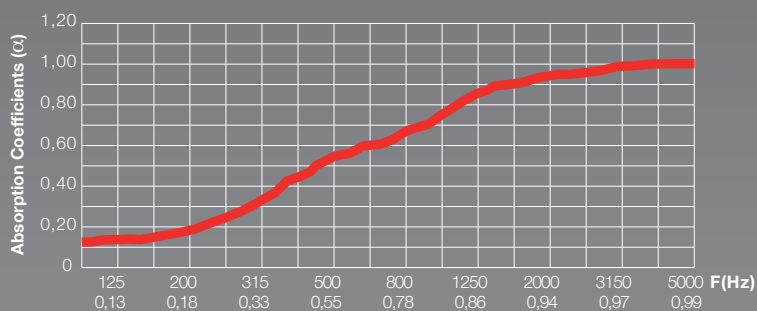

HALOS ACOUSTIC

L'acustica è un fattore di fondamentale importanza nella progettazione degli ambienti, al fine di garantire il benessere psico-fisico di chi vive tali spazi. Questo vale per i luoghi di lavoro, dove la capacità di riduzione del rumore coincide con un aumento di produttività, concentrazione e benessere generale, ma anche per i luoghi del tempo libero e l'abitazione, in cui si ricerca un'atmosfera confortevole per rigenerarsi dallo stress quotidiano. Halos Acoustic rappresenta la massima integrazione tra comfort acustico e soluzione illuminotecnica, un prezioso strumento di progettazione per architetti e designer.

Acoustics is a fundamental factor in the design of environments, in order to ensure the psycho-physical well-being of those who live such spaces. This applies to workplaces, where the ability to reduce noise coincides with an increase in productivity, concentration and general well-being, but also to places of leisure and housing, where you look for a comfortable atmosphere to regenerate from everyday stress.

Halos Acoustic represents the best integration between acoustic comfort and lighting solution, a precious design tool for architects and designers.



HALOS ACOUSTIC

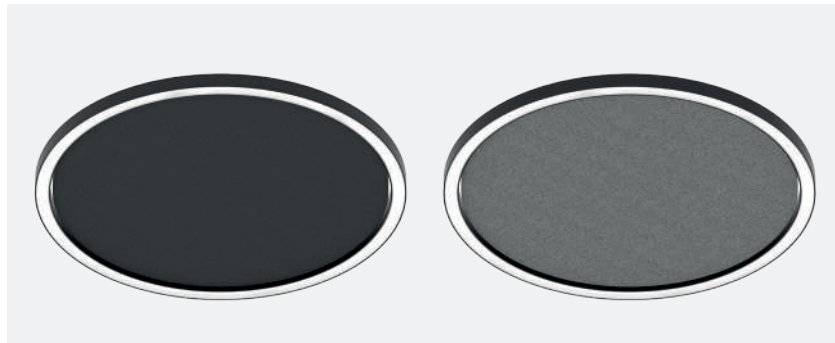

Apparecchio circolare a LED ad emissione diretta per installazione a plafone o sospensione, provvisto di pannello centrale fonoassorbente in fibre di poliestere 100% riciclabile. Per installazione singola o multipla, è ideato per la creazione di ambienti human-centric in cui il comfort acustico è indice di aumento di produttività, concentrazione e benessere generale. Le capacità acustiche del pannello, testate in camera riverberante, hanno prodotto un indice NRC (Noise Reduction Coefficient) pari a 0,6.

Disponibili due diverse finiture materiche NERO GRAFITE e GRIGIO IRON, la cui speciale lavorazione manuale rende unica ogni superficie.

Pannelli di colorazioni differenti, in verniciatura NCS o con stampa grafica in alta risoluzione sono disponibili su richiesta. Profilo in estruso di alluminio e rosini in acciaio verniciati a polvere, schermi diffusori in PMMA opale.

Per installazione a plafone prevedere alimentazione remota da ordinare a parte.

Per installazione a sospensione prevedere rosini con alimentazione integrata per cavi di sospensione convergenti o paralleli, oppure rosini per alimentazione remota unitamente a kit di sospensione e cavo di alimentazione. Alimentazione elettronica 220-240V 50/60Hz disponibile anche dimmerabile DALI/PUSH.

Circular LED fixture with direct light emission for ceiling or suspension installation, with central sound-absorbing panel made of 100% recyclable polyester fibers. For single or multiple installation, it is conceived for the creation of human-centric environments where acoustic comfort is an indication of increased productivity, concentration and general well-being.

The acoustic capacity of the panel, tested in a reverberating chamber, produced an NRC (Noise Reduction Coefficient) index of 0.6.

Available two different material finishes GRAPHITE BLACK and IRON GREY, whose special manual processing makes each surface unique.

Different colour panels, in NCS painting or with graphic printing in high resolution available on request.

Extruded aluminium profile and powder-coated steel canopy, opal PMMA diffuser screens.

For ceiling mounting it is required remote driver to be ordered separately.

For suspension mounting it is required canopy with integrated driver for converging or parallel suspension cables, or canopy for remote power with suspension kit and power cable. Electronic power supply 220-240V 50/60hz is also available dimmable DALI/PUSH.

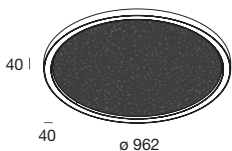

HALOS ACOUSTIC
nero grafite

HALOS ACOUSTIC
graphite black

2700K									
Ø (mm)	POWER	CODE	FLUX	FLUX	FLUX	FLUX	FLUX	FLUX	FLUX
962	62W	109901_	01 4643 lm	02	20	21	3947 lm	22	4179 lm
3000K									
Ø (mm)	POWER	CODE	FLUX	FLUX	FLUX	FLUX	FLUX	FLUX	FLUX
962	62W	109903_	01 4859 lm	02	20	21	4130 lm	22	4373 lm
4000K									
Ø (mm)	POWER	CODE	FLUX	FLUX	FLUX	FLUX	FLUX	FLUX	FLUX
962	62W	109905_	01 5246 lm	02	20	21	4459 lm	22	4721 lm

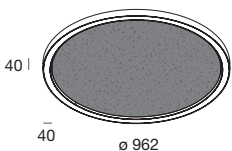

HALOS ACOUSTIC
grigio iron

HALOS ACOUSTIC
iron grey

2700K									
Ø (mm)	POWER	CODE	FLUX	FLUX	FLUX	FLUX	FLUX	FLUX	FLUX
962	62W	109902_	01 4643 lm	02	20	21	3947 lm	22	4179 lm
3000K									
Ø (mm)	POWER	CODE	FLUX	FLUX	FLUX	FLUX	FLUX	FLUX	FLUX
962	62W	109904_	01 4859 lm	02	20	21	4130 lm	22	4373 lm
4000K									
Ø (mm)	POWER	CODE	FLUX	FLUX	FLUX	FLUX	FLUX	FLUX	FLUX
962	62W	109906_	01 5246 lm	02	20	21	4459 lm	22	4721 lm

HALOS ACOUSTIC

ACCESSORI PER INSTALLAZIONE CON ALIMENTAZIONE REMOTA ACCESSORIES FOR REMOTE DRIVER MOUNTING



ROSONE PER INSTALLAZIONE SINGOLA
ALIMENTAZIONE REMOTA
Kit di sospensione, cavo di alimentazione
ed alimentatore da ordinare a parte.

CANOPY FOR SINGLE INSTALLATION
REMOTE DRIVER
Suspension kit, power cable and driver
to be ordered separately.

CODE					
105157._	01	02	20	21	22



ROSONE PER INSTALLAZIONE DOPPIA
ALIMENTAZIONE REMOTA
2 kit di sospensione, 2 cavi di alimentazione
e 2 alimentatori da ordinare a parte.

CANOPY FOR DOUBLE INSTALLATION
REMOTE DRIVER
2 suspension kits, 2 power cables
and 2 drivers to be ordered separately.

CODE					
105158._	01	02	20	21	22

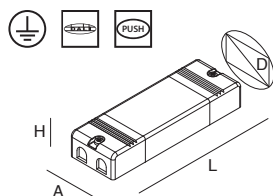

ALIMENTATORE ELETTRONICO
220-240V 50/60Hz

ELECTRONIC DRIVER
220-240V 50/60Hz

CODE	D (mm)	A (mm)	H (mm)	L (mm)
------	--------	--------	--------	--------

105147.99	105	100	31	235
------------------	-----	-----	----	-----

DALI-PUSH

CODE	D (mm)	A (mm)	H (mm)	L (mm)
------	--------	--------	--------	--------

105148.99	105	100	31	235
------------------	-----	-----	----	-----

3000

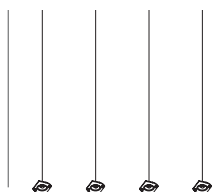

KIT SOSPENSIONE

SUSPENSION KIT

CODE	L (mm)
------	--------

105159.99	3000
------------------	------

3000



CAVO DI ALIMENTAZIONE
Trasparente, bianco o nero.

POWER CABLE
Transparent, white or black.

CODE		L (mm)
------	--	--------

109001._	00	3000
-----------------	-----------	------

CODE			L (mm)
------	--	--	--------

109001._	01	02	3000
-----------------	-----------	-----------	------

HALOS ACOUSTIC

ACCESSORI PER INSTALLAZIONE CON ALIMENTAZIONE INTEGRATA ACCESSORIES FOR INTEGRATED DRIVER MOUNTING



ROSONE PER CAVI CONVERGENTI
PER INSTALLAZIONE SINGOLA
ALIMENTAZIONE INTEGRATA
Kit di sospensione e cavo di alimentazione
da ordinare a parte.

CANOPY FOR CONVERGING CABLES
FOR SINGLE INSTALLATION
INTEGRATED DRIVER
Suspension kit and power cable to be ordered separately.

CODE	<input type="checkbox"/>	<input checked="" type="checkbox"/>	<input type="checkbox"/>	<input type="checkbox"/>	<input type="checkbox"/>
105149._	01	02	20	21	22

DALI-PUSH	<input type="checkbox"/>	<input checked="" type="checkbox"/>	<input type="checkbox"/>	<input type="checkbox"/>	<input type="checkbox"/>
CODE	<input type="checkbox"/>	<input checked="" type="checkbox"/>	<input type="checkbox"/>	<input type="checkbox"/>	<input type="checkbox"/>
105150._	01	02	20	21	22

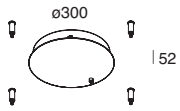

ROSONE PER CAVI PARALLELI
PER INSTALLAZIONE SINGOLA
ALIMENTAZIONE INTEGRATA
Kit di sospensione e cavo di alimentazione
da ordinare a parte.

CANOPY FOR PARALLEL CABLES
FOR SINGLE INSTALLATION
INTEGRATED DRIVER
Suspension kit and power cable to be ordered separately.

CODE	<input type="checkbox"/>	<input checked="" type="checkbox"/>	<input type="checkbox"/>	<input type="checkbox"/>	<input type="checkbox"/>
105151._	01	02	20	21	22

DALI-PUSH	<input type="checkbox"/>	<input checked="" type="checkbox"/>	<input type="checkbox"/>	<input type="checkbox"/>	<input type="checkbox"/>
CODE	<input type="checkbox"/>	<input checked="" type="checkbox"/>	<input type="checkbox"/>	<input type="checkbox"/>	<input type="checkbox"/>
105152._	01	02	20	21	22

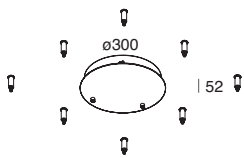

ROSONE PER CAVI PARALLELI
PER INSTALLAZIONE DOPPIA
ALIMENTAZIONE INTEGRATA
2 kit di sospensione e 2 cavi di alimentazione
da ordinare a parte.

CANOPY FOR PARALLEL CABLES
FOR DOUBLE INSTALLATION
INTEGRATED DRIVER
2 suspension kits and 2 power cables
to be ordered separately.

CODE	<input type="checkbox"/>	<input checked="" type="checkbox"/>	<input type="checkbox"/>	<input type="checkbox"/>	<input type="checkbox"/>
105155._	01	02	20	21	22

DALI-PUSH	<input type="checkbox"/>	<input checked="" type="checkbox"/>	<input type="checkbox"/>	<input type="checkbox"/>	<input type="checkbox"/>
CODE	<input type="checkbox"/>	<input checked="" type="checkbox"/>	<input type="checkbox"/>	<input type="checkbox"/>	<input type="checkbox"/>
105156._	01	02	20	21	22

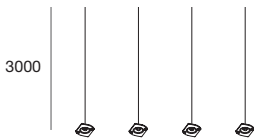

KIT SOSPENSIONE
SUSPENSION KIT

CODE		L (mm)
105159.99		3000



CAVO DI ALIMENTAZIONE
Trasparente, bianco o nero.
POWER CABLE
Transparent, white or black.

CODE	<input checked="" type="checkbox"/>	L (mm)
109001._	00	3000

CODE	<input type="checkbox"/>	<input checked="" type="checkbox"/>	L (mm)
109001._	01	02	3000



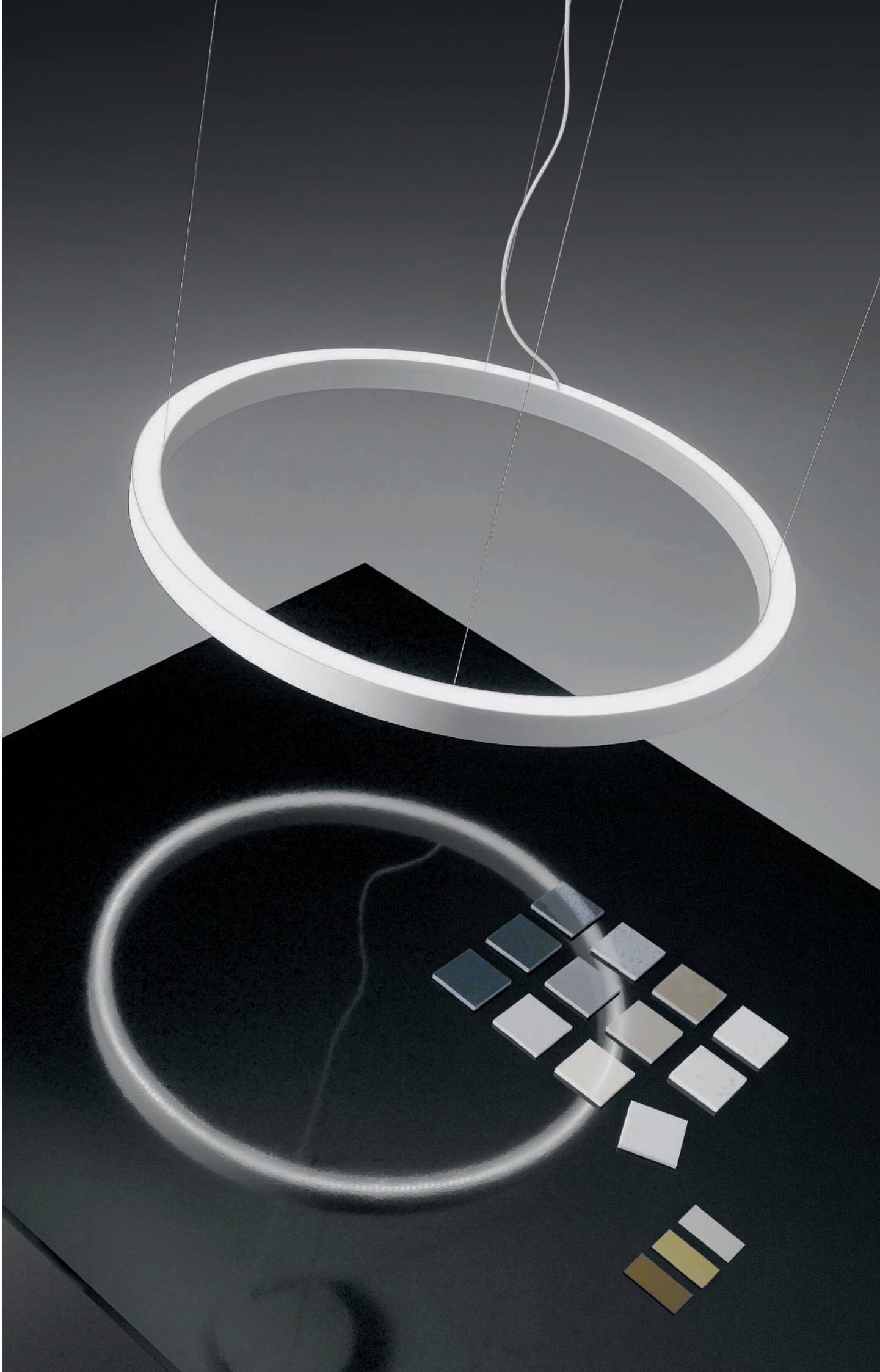



HALOS B

Anelli LED decorativi inconfondibili e d'impatto. Profili LED circolari a sospensione, con luce diretta e indiretta, doppia accensione. Illuminazione Novalux disponibile nei colori bianco, nero, e nelle nuove tonalità oro, caffè e cappuccino. HALOS B è un apparecchio luminoso ad alta resa cromatica perfetto per decorare spazi residenziali e ambienti professionali.

Unmistakable and impactful decorative LED rings. Circular LED pendant profiles with direct and indirect light, dual switching. Novalux lighting available in white, black and the new gold, coffee and cappuccino shades. HALOS B is a luminaire with high colour rendering, ideal for decorating residential and professional spaces.

HALOS B

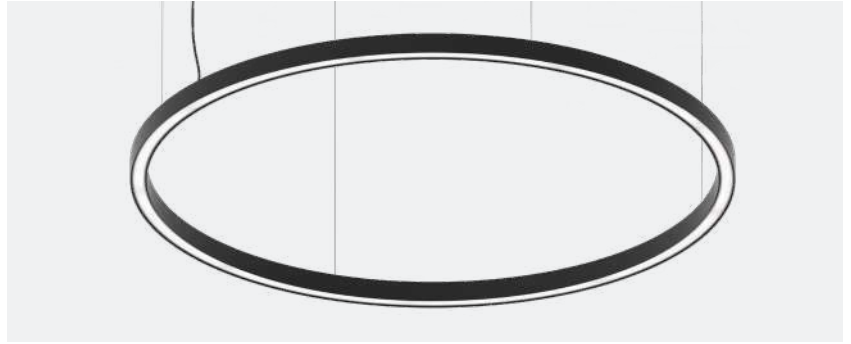

Profilo LED circolare per installazione a sospensione ad emissione di luce diretta-indiretta, con doppia accensione.

Corpo in estruso di alluminio e rosoni in acciaio verniciati a polvere, schermi diffusori in PMMA opale. Disponibili rosoni con alimentazione integrata per cavi di sospensione convergenti o paralleli, oppure rosoni per alimentazione remota. Alimentazione elettronica 220-240V 50/60Hz disponibile anche DALI/PUSH.



Circular LED profile for suspension installation with direct-indirect light output, with double switch.

Extruded aluminum body and powder-coated steel canopy, opal PMMA diffuser screens. Canopies with integrated driver are available for converging or parallel suspension cables, or rosettes for remote power supply. Electronic power supply 220-240V 50/60hz also available DALI/PUSH.

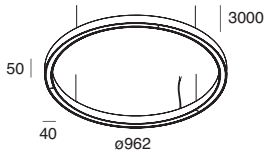

HALOS B 962

4 cavi di sospensione L. 3000 mm e cavo di alimentazione inclusi (4x0,5mmq per bianco e nero o 4x0,75 mmq trasparente per gli altri colori). Rosone per alimentazione remota o integrata da ordinare a parte.

4 suspension cables L. 3000 mm and power cable included (4x0,5 mmq for white and black or 4x0,75mmq transparent for other colours). Canopy for remote or integrated power supply to be ordered separately.

2700K

Ø (mm)	POWER	CODE	□ FLUX	■ FLUX	■ FLUX	■ FLUX	■ FLUX
962	124W	107119_	01 11933 lm	02 10144 lm	20 10144 lm	21 10144 lm	22 10740 lm

3000K

Ø (mm)	POWER	CODE	□ FLUX	■ FLUX	■ FLUX	■ FLUX	■ FLUX
962	124W	107120_	01 12488 lm	02 10614 lm	20 10614 lm	21 10614 lm	22 11239 lm

4000K

Ø (mm)	POWER	CODE	□ FLUX	■ FLUX	■ FLUX	■ FLUX	■ FLUX
962	124W	107121_	01 13482 lm	02 11460 lm	20 11460 lm	21 11460 lm	22 12133 lm

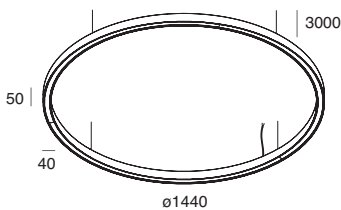

HALOS B 1440

4 cavi di sospensione L. 3000 mm e cavo di alimentazione inclusi (4x0,5mmq per bianco e nero o 4x0,75 mmq trasparente per gli altri colori). Rosone per alimentazione remota o integrata da ordinare a parte.

4 suspension cables L. 3000 mm and power cable included (4x0,5 mmq for white and black or 4x0,75mmq transparent for other colours). Canopy for remote or integrated power supply to be ordered separately.

2700K

Ø (mm)	POWER	CODE	□ FLUX	■ FLUX	■ FLUX	■ FLUX	■ FLUX
1440	186W	107122_	01 17900 lm	02 15214 lm	20 15214 lm	21 15214 lm	22 16109 lm

3000K

Ø (mm)	POWER	CODE	□ FLUX	■ FLUX	■ FLUX	■ FLUX	■ FLUX
1440	186W	107123_	01 18733 lm	02 15921 lm	20 15921 lm	21 15921 lm	22 16859 lm

4000K

Ø (mm)	POWER	CODE	□ FLUX	■ FLUX	■ FLUX	■ FLUX	■ FLUX
1440	186W	107124_	01 20223 lm	02 17188 lm	20 17188 lm	21 17188 lm	22 18201 lm

HALOS B

ACCESSORI PER INSTALLAZIONE CON ALIMENTAZIONE REMOTA
ACCESSORIES FOR REMOTE DRIVER MOUNTING

ROSONE PER
INSTALLAZIONE SINGOLA
ALIMENTAZIONE REMOTA
Alimentatore elettronico da ordinare
a parte.

CANOPY FOR
SINGLE INSTALLATION
REMOTE DRIVER
Electronic driver to be ordered separately.

CODE
105157... 01 02 20 21 22

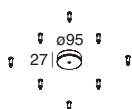

ROSONE PER
INSTALLAZIONE DOPPIA
ALIMENTAZIONE REMOTA
2 alimentatori elettronici da ordinare
a parte.

CANOPY FOR
DOUBLE INSTALLATION
REMOTE DRIVER
2 electronic drivers to be ordered
separately.

CODE
105158... 01 02 20 21 22

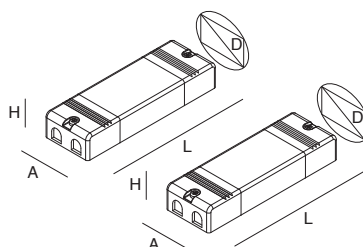

COPIA DI ALIMENTATORI
ELETTRONICI
230-240V 50/60 Hz
Per versioni 962mm e 1440mm.

COUPLE OF ELECTRONIC DRIVERS
230-240V 50/60 Hz
Suitable for both versions 962mm
and 1440mm.

CODE

D (mm)	A (mm)	H (mm)	L (mm)
105	100	31	235

DALI-PUSH

CODE

D (mm)	A (mm)	H (mm)	L (mm)
105	100	31	235

HALOS B

ACCESSORI PER INSTALLAZIONE CON ALIMENTAZIONE INTEGRATA
ACCESSORIES FOR INTEGRATED DRIVER MOUNTING

ROSONE PER
CAVI CONVERGENTI
ALIMENTAZIONE INTEGRATA
Per versioni 962mm e 1440mm.
Prevista accensione unica per
gestione PUSH.

CANOPY FOR
CONVERGING CABLES
INTEGRATED DRIVER
Suitable for both versions 962mm
and 1440mm.
Single switch for PUSH management.

CODE
107127... 01 02 20 21 22

DALI-PUSH

CODE
107128... 01 02 20 21 22

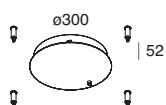

ROSONE PER
CAVI PARALLELI
ALIMENTAZIONE INTEGRATA
Per versioni 962mm e 1440mm.
Prevista accensione unica per gestione
PUSH.

CANOPY FOR
PARALLEL CABLES
INTEGRATED DRIVER
Suitable for both versions 962mm and
1440mm.
Single switch for PUSH management.

CODE
107129... 01 02 20 21 22

DALI-PUSH

CODE
107130... 01 02 20 21 22









HALOS MINI

La versione più essenziale ed elegante della famiglia HALOS, capace di aggiungere un tocco di luce sofisticato ad ogni ambiente. HALOS MINI è un profilo LED circolare e minimale ad emissione di luce interna. Illuminazione Novalux a sospensione orizzontale o verticale, ora anche nella versione applique.

The most essential and elegant version of the HALOS family, which is able to add a sophisticated touch of light to any environment. HALOS MINI is a circular and minimal LED profile with internal light emission. Novalux lighting with horizontal or vertical suspension, now also in the wall lamp version.

HALOS MINI ORIZZONTALE

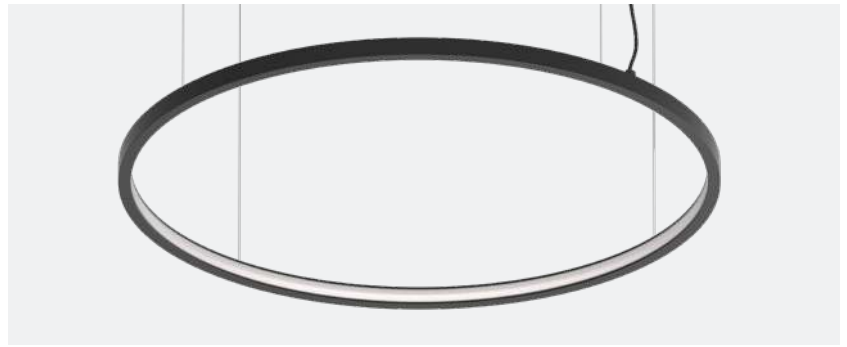

Profilo LED circolare per installazione a sospensione orizzontale ad emissione di luce diffusa interna. Corpo in estruso di alluminio e rosone in acciaio verniciato a polvere, schermi diffusori in PMMA opale. Disponibili rosone con alimentazione integrata oppure rosone per alimentazione remota. Alimentatore elettronico 220-240V 50/60Hz disponibile anche DALI/PUSH.

Circular LED profile for horizontal suspension installation with internal diffused light emission. Extruded aluminum body and powder-coated steel canopies, opal PMMA diffuser screens. Canopies with integrated power supply or for remote power supply are available. Electronic driver 220-240V 50/60hz also available DALI/PUSH.

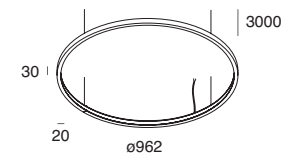
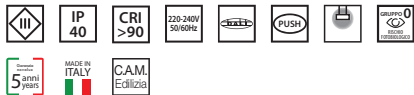

HALOS MINI ORIZZONTALE 962

4 cavi di sospensione L. 3000 mm e cavo di alimentazione inclusi (2x0,5mmq per bianco e nero o 2x0,75 mmq trasparente per gli altri colori). Rosone per alimentazione remota o integrata da ordinare a parte.

4 suspension cables L. 3000 mm and power cable included (2x0,5 mmq for white and black or 2x0,75mmq transparent for other colours). Canopy for remote or integrated power supply to be ordered separately.

2700K

Ø (mm)	POWER	CODE	FLUX	FLUX	FLUX	FLUX	FLUX
962	62W	107332...	01 3600 lm	02 3059 lm	20 3059 lm	21 3059 lm	22 3239 lm

3000K

Ø (mm)	POWER	CODE	FLUX	FLUX	FLUX	FLUX	FLUX
962	62W	107333...	01 3883 lm	02 3300 lm	20 3300 lm	21 3300 lm	22 3494 lm

4000K

Ø (mm)	POWER	CODE	FLUX	FLUX	FLUX	FLUX	FLUX
962	62W	107334...	01 3936 lm	02 3345 lm	20 3345 lm	21 3345 lm	22 3541 lm

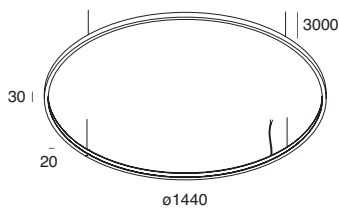

HALOS MINI ORIZZONTALE 1440

4 cavi di sospensione L. 3000 mm e cavo di alimentazione inclusi (2x0,5mmq per bianco e nero o 2x0,75 mmq trasparente per gli altri colori). Rosone per alimentazione remota o integrata da ordinare a parte.

4 suspension cables L. 3000 mm and power cable included (2x0,5 mmq for white and black or 2x0,75mmq transparent for other colours). Canopy for remote or integrated power supply to be ordered separately.

2700K

Ø (mm)	POWER	CODE	FLUX	FLUX	FLUX	FLUX	FLUX
1440	93W	107335...	01 5400 lm	02 4590 lm	20 4590 lm	21 4590 lm	22 4859 lm

3000K

Ø (mm)	POWER	CODE	FLUX	FLUX	FLUX	FLUX	FLUX
1440	93W	107336...	01 5825 lm	02 4950 lm	20 4950 lm	21 4950 lm	22 5242 lm

4000K

Ø (mm)	POWER	CODE	FLUX	FLUX	FLUX	FLUX	FLUX
1440	93W	107337...	01 5905 lm	02 5019 lm	20 5019 lm	21 5019 lm	22 5314 lm

HALOS MINI ORIZZONTALE

ACCESSORI PER INSTALLAZIONE CON ALIMENTAZIONE REMOTA ACCESSORIES FOR REMOTE DRIVER MOUNTING



ROSONE PER INSTALLAZIONE SINGOLA
ALIMENTAZIONE REMOTA
alimentatore elettronico da ordinare a parte.

CANOPY FOR SINGLE INSTALLATION
REMOTE DRIVER
Electronic driver to be ordered separately.

CODE

105157._ 01 02 20 21 22



ROSONE PER INSTALLAZIONE DOPPIA
ALIMENTAZIONE REMOTA
2 alimentatori elettronici da ordinare a parte.

CANOPY FOR DOUBLE INSTALLATION
REMOTE DRIVER
2 electronic drivers to be ordered separately.

CODE

105158._ 01 02 20 21 22

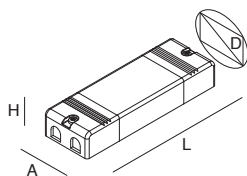

ALIMENTATORE ELETTRONICO
230-240V 50/60 Hz
Per versioni 962mm e 1440mm.

ELECTRONIC DRIVER
230-240V 50/60 Hz
Suitable for both versions 962mm
and 1440mm.

CODE D (mm) A (mm) H (mm) L (mm)

105147.99 105 100 31 235

DALI-PUSH

CODE D (mm) A (mm) H (mm) L (mm)

105148.99 105 100 31 235

HALOS MINI ORIZZONTALE

ACCESSORI PER INSTALLAZIONE CON ALIMENTAZIONE INTEGRATA ACCESSORIES FOR INTEGRATED DRIVER MOUNTING



ROSONE PER CAVI CONVERGENTI
- PER INSTALLAZIONE SINGOLA
ALIMENTAZIONE INTEGRATA
Per versioni 962mm e 1440mm.

CANOPY FOR CONVERGING CABLES
- FOR SINGLE INSTALLATION
INTEGRATED DRIVER
Suitable for both versions 962mm
and 1440mm.

CODE

105149._ 01 02 20 21 22

DALI-PUSH

CODE

105150._ 01 02 20 21 22



ROSONE PER CAVI CONVERGENTI
- PER INSTALLAZIONE DOPPIA
ALIMENTAZIONE INTEGRATA
Per versioni 962mm e 1440mm.

CANOPY FOR CONVERGING CABLES
- FOR DOUBLE INSTALLATION
INTEGRATED DRIVER
Suitable for both versions 962mm
and 1440mm.

CODE

105153._ 01 02 20 21 22

DALI-PUSH

CODE

105154._ 01 02 20 21 22

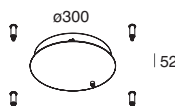

ROSONE PER CAVI PARALLELI
- PER INSTALLAZIONE SINGOLA
ALIMENTAZIONE INTEGRATA
Per versioni 962mm e 1440mm.

CANOPY FOR PARALLEL CABLES -
FOR SINGLE INSTALLATION
INTEGRATED DRIVER
Suitable for both versions 962mm
and 1440mm.

CODE

105151._ 01 02 20 21 22

DALI-PUSH

CODE

105152._ 01 02 20 21 22

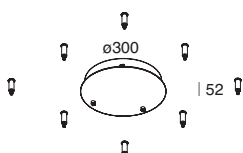

ROSONE PER CAVI PARALLELI
- PER INSTALLAZIONE DOPPIA
ALIMENTAZIONE INTEGRATA
Per versioni 962mm e 1440mm.

CANOPY FOR PARALLEL CABLES
- FOR DOUBLE INSTALLATION
INTEGRATED DRIVER
Suitable for both versions 962mm
and 1440mm.

CODE

105155._ 01 02 20 21 22

DALI-PUSH

CODE

105156._ 01 02 20 21 22

HALOS MINI VERTICALE



Profilo LED circolare per installazione a sospensione verticale ad emissione di luce diffusa interna. Corpo in estruso di alluminio e rosone in acciaio verniciato a polvere, schermi diffusori in PMMA opale. Disponibili rosone con alimentazione integrata oppure rosone per alimentazione remota. Alimentatore elettronico 220-240V 50/60Hz disponibile anche DALI/PUSH.

Circular LED profile for vertical suspension installation with internal diffused light emission. Extruded aluminum body and powder-coated steel canopies, opal PMMA diffuser screens. Canopies with integrated power supply or for remote power supply are available. Electronic driver 220-240V 50/60hz also available DALI/PUSH.

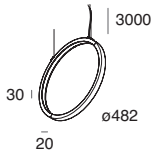

HALOS MINI VERTICALE 482

2 cavi di sospensione L. 3000 mm e cavo di alimentazione inclusi (2x0,5mmq per bianco e nero o 2x0,75 mmq trasparente per gli altri colori). Rosone per alimentazione remota o integrata da ordinare a parte.

2 suspension cables L. 3000 mm and power cable included (2x0,5 mmq for white and black or 2x0,75mmq transparent for other colours). Canopy for remote or integrated power supply to be ordered separately.

2700K

Ø (mm)	POWER	CODE	<input type="checkbox"/> FLUX	<input checked="" type="checkbox"/> FLUX	<input type="checkbox"/> FLUX	<input type="checkbox"/> FLUX	<input type="checkbox"/> FLUX		
482	24W	107338 ...	01	1331 lm	02	1131 lm	20 1131 lm	21 1131 lm	22 1197 lm

3000K

Ø (mm)	POWER	CODE	<input type="checkbox"/> FLUX	<input checked="" type="checkbox"/> FLUX	<input type="checkbox"/> FLUX	<input type="checkbox"/> FLUX	<input type="checkbox"/> FLUX		
482	24W	107339 ...	01	1435 lm	02	1219 lm	20 1219 lm	21 1219 lm	22 1291 lm

4000K

Ø (mm)	POWER	CODE	<input type="checkbox"/> FLUX	<input checked="" type="checkbox"/> FLUX	<input type="checkbox"/> FLUX	<input type="checkbox"/> FLUX	<input type="checkbox"/> FLUX		
482	24W	107340 ...	01	1472 lm	02	1251 lm	20 1251 lm	21 1251 lm	22 1324 lm

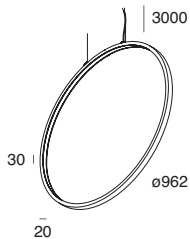

HALOS MINI VERTICALE 962

2 cavi di sospensione L. 3000 mm e cavo di alimentazione inclusi (2x0,5mmq per bianco e nero o 2x0,75 mmq trasparente per gli altri colori). Rosone per alimentazione remota o integrata da ordinare a parte.

2 suspension cables L. 3000 mm and power cable included (2x0,5 mmq for white and black or 2x0,75mmq transparent for other colours). Canopy for remote or integrated power supply to be ordered separately.

2700K

Ø (mm)	POWER	CODE	<input type="checkbox"/> FLUX	<input checked="" type="checkbox"/> FLUX	<input type="checkbox"/> FLUX	<input type="checkbox"/> FLUX	<input type="checkbox"/> FLUX		
962	48W	107341 ...	01	2799 lm	02	2378 lm	20 2378 lm	21 2378 lm	22 2518 lm

3000K

Ø (mm)	POWER	CODE	<input type="checkbox"/> FLUX	<input checked="" type="checkbox"/> FLUX	<input type="checkbox"/> FLUX	<input type="checkbox"/> FLUX	<input type="checkbox"/> FLUX		
962	48W	107342 ...	01	3018 lm	02	2566 lm	20 2566 lm	21 2566 lm	22 2716 lm

4000K

Ø (mm)	POWER	CODE	<input type="checkbox"/> FLUX	<input checked="" type="checkbox"/> FLUX	<input type="checkbox"/> FLUX	<input type="checkbox"/> FLUX	<input type="checkbox"/> FLUX		
962	48W	107343 ...	01	3060 lm	02	2601 lm	20 2601 lm	21 2601 lm	22 2753 lm

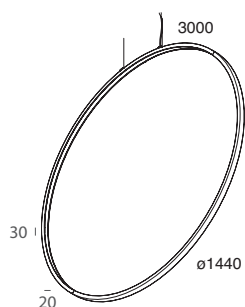
**HALOS MINI VERTICALE 1440**

2 cavi di sospensione L. 3000 mm e cavo di alimentazione inclusi (2x0,5mmq per bianco e nero o 2x0,75 mmq trasparente per gli altri colori).
Rosone per alimentazione remota o integrata da ordinare a parte.

2 suspension cables L. 3000 mm and power cable included (2x0,5 mmq for white and black or 2x0,75mmq transparent for other colours).
Canopy for remote or integrated power supply to be ordered separately.

2700K

Ø (mm)	POWER	CODE	FLUX	FLUX	FLUX	FLUX	FLUX
1440	72W	107344_	01 4198 lm	02 3567 lm	20 3567 lm	21 3567 lm	22 3777 lm

3000K

Ø (mm)	POWER	CODE	FLUX	FLUX	FLUX	FLUX	FLUX
1440	72W	107345_	01 4527 lm	02 3849 lm	20 3849 lm	21 3849 lm	22 4074 lm

4000K

Ø (mm)	POWER	CODE	FLUX	FLUX	FLUX	FLUX	FLUX
1440	72W	107346_	01 4590 lm	02 3902 lm	20 3902 lm	21 3902 lm	22 4131 lm

HALOS MINI VERTICALE**ACCESSORI PER INSTALLAZIONE CON ALIMENTAZIONE REMOTA
ACCESSORIES FOR REMOTE DRIVER MOUNTING**

ROSONE PER INSTALLAZIONE SINGOLA
ALIMENTAZIONE REMOTA
Alimentatore elettronico
da ordinare a parte.

CODE	FLUX	FLUX	FLUX	FLUX	FLUX
107347_	01	02	20	21	22

CANOPY FOR SINGLE INSTALLATION
REMOTE DRIVER
Electronic driver to be ordered separately.

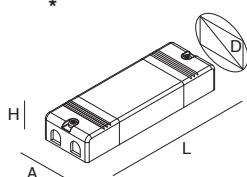

ALIMENTATORE ELETTRONICO
220-240V 50/60Hz

ELECTRONIC DRIVER
220-240V 50/60Hz

CODE	VERSION	D (mm)	A (mm)	H (mm)	L (mm)	
* 107324.99		482 mm	54	44	30	147
105103.99		962 mm	91	85	31	220
105109.99		1440 mm	105	100	31	235

DALI-PUSH

CODE	VERSION	D (mm)	A (mm)	H (mm)	L (mm)	
107325.99		482 mm	86	80	30	124
105104.99		962 mm	91	85	31	220
105110.99		1440 mm	105	100	31	235

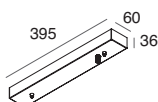
HALOS MINI VERTICALE**ACCESSORI PER INSTALLAZIONE CON ALIMENTAZIONE INTEGRATA
ACCESSORIES FOR INTEGRATED DRIVER MOUNTING**

ROSONE ALIMENTATATO
Alimentazione integrata.

FEED CANOPY
Integrated driver.

CODE	FLUX	FLUX	FLUX	FLUX	VERSION
107326_	01	02	20	21	22 482 mm - 962 mm - 1440 mm

DALI-PUSH

CODE	FLUX	FLUX	FLUX	FLUX	VERSION
107329_	01	02	20	21	22 482 mm
107330_	01	02	20	21	22 962 mm - 1440 mm

HALOS MINI APPLIQUE



Profilo LED circolare per installazione a parete a luce interna.
Corpo in estruso di alluminio verniciato a polvere e schermo in PMMA opale.
Staffe per il montaggio a parete integrate, alimentazione remota da ordinare a parte.

Circular LED profile for wall surface mounting with internal light emission.
Body in powder-coated extruded aluminium and PMMA opal screen.
Integrated wall mounting brackets, remote power supply to be ordered separately.



HALOS MINI APPLIQUE 482

2700K

Ø (mm)	POWER	CODE	<input type="checkbox"/> FLUX	<input checked="" type="checkbox"/> FLUX	<input checked="" type="checkbox"/> FLUX	<input checked="" type="checkbox"/> FLUX	<input checked="" type="checkbox"/> FLUX	<input checked="" type="checkbox"/> FLUX				
482	24W	107348...	01	1331 lm	02	1131 lm	20	1131 lm	21	1131 lm	22	1197 lm

3000K

Ø (mm)	POWER	CODE	<input type="checkbox"/> FLUX	<input checked="" type="checkbox"/> FLUX	<input checked="" type="checkbox"/> FLUX	<input checked="" type="checkbox"/> FLUX	<input checked="" type="checkbox"/> FLUX	<input checked="" type="checkbox"/> FLUX				
482	24W	107349...	01	1435 lm	02	1219 lm	20	1219 lm	21	1219 lm	22	1291 lm

4000K

Ø (mm)	POWER	CODE	<input type="checkbox"/> FLUX	<input checked="" type="checkbox"/> FLUX	<input checked="" type="checkbox"/> FLUX	<input checked="" type="checkbox"/> FLUX	<input checked="" type="checkbox"/> FLUX	<input checked="" type="checkbox"/> FLUX				
482	24W	107350...	01	1472 lm	02	1251 lm	20	1251 lm	21	1251 lm	22	1324 lm

HALOS MINI APPLIQUE

ACCESSORI ACCESSORIES

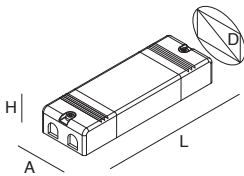
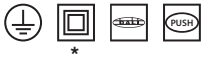

ALIMENTATORE
ELETTRONICO
220-240V 50/60Hz

ELECTRONIC DRIVER
220-240V 50/60Hz

CODE	VERSION	D (mm)	A (mm)	H (mm)	L (mm)
* 107324.99	482 mm	54	44	30	147

DALI-PUSH

CODE	VERSION	D (mm)	A (mm)	H (mm)	L (mm)
107325.99	482 mm	86	80	30	124







HALOS

Luce e armonia definiscono questi suggestivi anelli decorativi luminosi. Profilo LED circolare a luce diretta o a luce interna, nelle cinque versioni bianco, nero, caffè, cappuccino e oro, per installazione a sospensione, plafone o parete. Gli anelli di luce HALOS sono prodotti di illuminazione Novalux che aggiungono un dettaglio delicato e sofisticato, ma di grande impatto scenico, per illuminare ambienti residenziali e commerciali.

Light and harmony define these striking decorative light rings. Circular LED profile with direct light or internal light, in five versions white, black, coffee, cappuccino and gold, for pendant, ceiling or wall mounting. HALOS light rings are Novalux lighting products that add a subtle and sophisticated yet striking detail to illuminate residential and commercial environments.

HALOS EMISSIONE DIRETTA

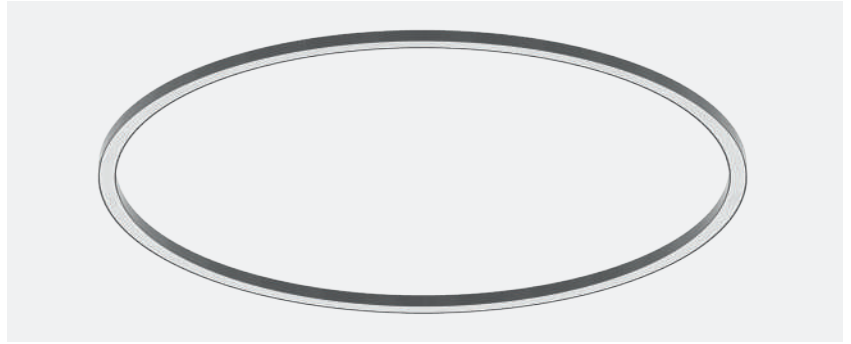

Profilo LED circolare a luce diretta, per installazione a sospensione, plafone o parete.
Corpo in estruso di alluminio e rosoni in acciaio verniciato a polvere, schermo diffusore in PMMA opale.
Per installazione a plafone/parete prevedere alimentazione remota da ordinare a parte.
Per installazione a sospensione prevedere il kit con cavi di sospensione convergenti, e alimentatore elettronico integrato nel rosone, oppure il kit con cavi di sospensione e rosone e alimentatore elettronico remoto da ordinare a parte.



Circular LED profile with direct light emission, for suspended, wall or ceiling mounting.
Body made of extruded aluminium, canopy made of powder coated steel and PMMA opal diffuser.
For ceiling/wall mounting it is required the remote electronic driver to be ordered separately.
For suspension mounting it is required the convergent suspension cables and integrated electronic driver kit, or the suspension cables and canopy kit adding the remote electronic driver to be ordered separately.

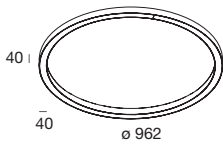

HALOS 962
Emissione diretta
Direct emission

2700K							
Ø (mm)	POWER	CODE	□ FLUX	■ FLUX	■ FLUX	■ FLUX	
962	62W	105135_..	01 4643 lm	02 3947 lm	20 3947 lm	21 3947 lm	22 4179 lm
3000K							
Ø (mm)	POWER	CODE	□ FLUX	■ FLUX	■ FLUX	■ FLUX	
962	62W	105136_..	01 4859 lm	02 4130 lm	20 4130 lm	21 4130 lm	22 4373 lm
4000K							
Ø (mm)	POWER	CODE	□ FLUX	■ FLUX	■ FLUX	■ FLUX	
962	62W	105137_..	01 5246 lm	02 4459 lm	20 4459 lm	21 4459 lm	22 4721 lm

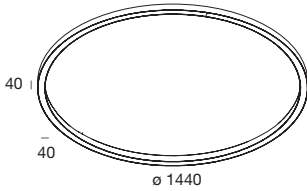

HALOS 1440
Emissione diretta
Direct emission

2700K							
Ø (mm)	POWER	CODE	□ FLUX	■ FLUX	■ FLUX	■ FLUX	
1440	93W	105138_..	01 6965 lm	02 5920 lm	20 5920 lm	21 5920 lm	22 6268 lm
3000K							
Ø (mm)	POWER	CODE	□ FLUX	■ FLUX	■ FLUX	■ FLUX	
1440	93W	105139_..	01 7289 lm	02 6195 lm	20 6195 lm	21 6195 lm	22 6560 lm
4000K							
Ø (mm)	POWER	CODE	□ FLUX	■ FLUX	■ FLUX	■ FLUX	
1440	93W	105140_..	01 7869 lm	02 6688 lm	20 6688 lm	21 6688 lm	22 7082 lm

HALOS

EMISSIONE INTERNA

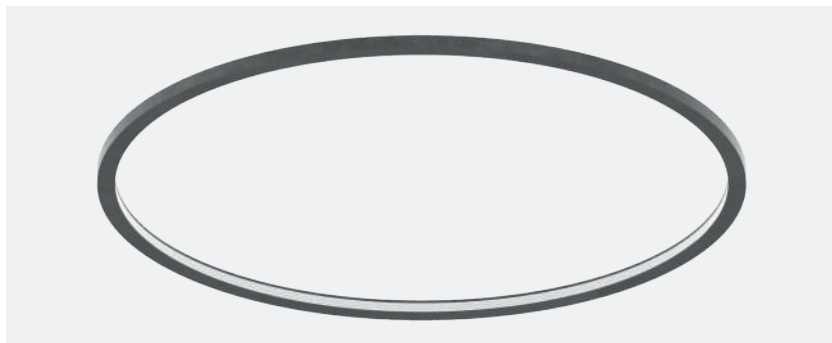

Profilo LED circolare a luce interna, per installazione a sospensione, plafone o parete.
Corpo in estruso di alluminio e rosoni in acciaio verniciato a polvere, schermo diffusore in policarbonato opale. Per installazione a plafone/parete prevedere alimentazione remota da ordinare a parte. Per installazione a sospensione prevedere il kit con cavi di sospensione convergenti, e alimentatore elettronico integrato nel rosone, oppure il kit con cavi di sospensione e rosone e alimentatore elettronico remoto da ordinare a parte.

Circular LED profile with internal light emission, for suspended, wall or ceiling mounting.
Body made of extruded aluminium, canopy made of powder coated steel and polycarbonate opal diffuser. For ceiling/wall mounting it is required the remote electronic driver to be ordered separately. For suspension mounting it is required the convergent suspension cables and integrated electronic driver kit, or the suspension cables and canopy kit adding the remote electronic driver to be ordered separately.

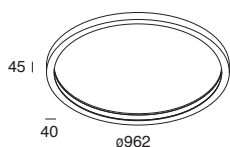
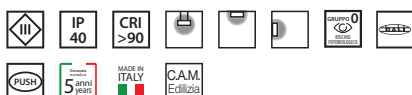

HALOS 962
Emissione interna
Internal emission

2700K										
Ø (mm)	POWER	CODE	FLUX	FLUX	FLUX	FLUX	FLUX	FLUX		
962	62W	105141_	01 3005 lm	02 2553 lm	20 2553 lm	21 2553 lm	22 2703 lm			
3000K										
Ø (mm)	POWER	CODE	FLUX	FLUX	FLUX	FLUX	FLUX	FLUX		
962	62W	105142_	01 3241 lm	02 2754 lm	20 2754 lm	21 2754 lm	22 2916 lm			
4000K										
Ø (mm)	POWER	CODE	FLUX	FLUX	FLUX	FLUX	FLUX	FLUX		
962	62W	105143_	01 3342 lm	02 2840 lm	20 2840 lm	21 2840 lm	22 3007 lm			

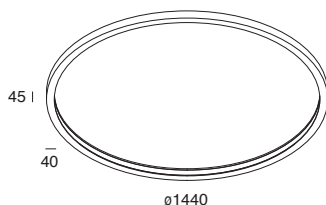

HALOS 1440
Emissione interna
Internal emission

2700K										
Ø (mm)	POWER	CODE	FLUX	FLUX	FLUX	FLUX	FLUX	FLUX		
1440	93W	105144_	01 4507 lm	02 3829 lm	20 3829 lm	21 3829 lm	22 4054 lm			
3000K										
Ø (mm)	POWER	CODE	FLUX	FLUX	FLUX	FLUX	FLUX	FLUX		
1440	93W	105145_	01 4861 lm	02 4131 lm	20 4131 lm	21 4131 lm	22 4374 lm			
4000K										
Ø (mm)	POWER	CODE	FLUX	FLUX	FLUX	FLUX	FLUX	FLUX		
1440	93W	105146_	01 5013 lm	02 4259 lm	20 4259 lm	21 4259 lm	22 4510 lm			

HALOS

ACCESSORI PER INSTALLAZIONE A SOSPENSIONE / PLAFONE / PARETE CON ALIMENTAZIONE REMOTA ACCESSORIES FOR SUSPENSION / CEILING / WALL MOUNTING WITH REMOTE DRIVER



ROSONE PER INSTALLAZIONE SINGOLA
ALIMENTAZIONE REMOTA
Kit di sospensione, cavo di alimentazione ed
alimentatore elettronico da ordinare a parte.

CANOPY FOR SINGLE INSTALLATION
REMOTE DRIVER
Suspension kit, power cable and electronic
driver to be ordered separately.

CODE

105157._ 01 02 20 21 22



ROSONE PER INSTALLAZIONE DOPPIA
ALIMENTAZIONE REMOTA
2 kit di sospensione, 2 cavi di alimentazione ed
alimentatori elettronici da ordinare a parte.

CANOPY FOR DOUBLE INSTALLATION
REMOTE DRIVER
2 Suspension kits, 2 power cables and
electronic drivers to be ordered separately.

CODE

105158._ 01 02 20 21 22

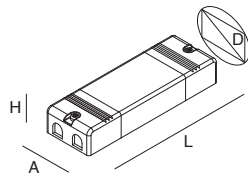

ALIMENTATORE ELETTRONICO
230-240V 50/60 Hz
Per versioni 962mm e 1440mm.

ELECTRONIC DRIVER
230-240V 50/60 Hz
Suitable for both versions 962mm
and 1440mm.

CODE D (mm) A (mm) H (mm) L (mm)

105147.99 105 100 31 235

DALI-PUSH

CODE D (mm) A (mm) H (mm) L (mm)

105148.99 105 100 31 235

3000

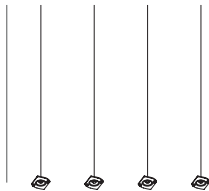

KIT SOSPENSIONE

SUSPENSION KIT

CODE L (mm)

105159.99 3000

3000



CAVO DI ALIMENTAZIONE
Trasparente, bianco o nero.

POWER CABLE
Transparent, white or black.

CODE L (mm)

109001._ 00 3000

CODE L (mm)

109001._ 01 02 3000

HALOS**ACCESSORI PER INSTALLAZIONE A SOSPENSIONE CON ALIMENTAZIONE INTEGRATA**
ACCESSORIES FOR SUSPENSION MOUNTING WITH INTEGRATED DRIVER

52

ROSONE PER CAVI CONVERGENTI
- PER INSTALLAZIONE SINGOLA
ALIMENTAZIONE INTEGRATA
Per versioni 962mm e 1440mm.
Kit di sospensione e cavo di alimentazione da ordinare a parte.

CODE

105149_.. 01 02 20 21 22**DALI-PUSH**

CODE

105150_.. 01 02 20 21 22

CANOPY FOR CONVERGING CABLES
- FOR SINGLE INSTALLATION
INTEGRATED DRIVER
Suitable for both versions 962mm and 1440mm.
Suspension kit and power cable to be ordered separately.



52

ROSONE PER CAVI CONVERGENTI
- PER INSTALLAZIONE DOPPIA
ALIMENTAZIONE INTEGRATA
Per versioni 962mm e 1440mm.
2 kit sospensione e 2 cavi di alimentazione da ordinare a parte.

CODE

105153_.. 01 02 20 21 22**DALI-PUSH**

CODE

105154_.. 01 02 20 21 22

CANOPY FOR CONVERGING CABLES
- FOR DOUBLE INSTALLATION
INTEGRATED DRIVER
Suitable for both versions 962mm and 1440mm.
Suspension kit and power cable to be ordered separately.

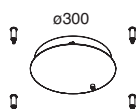

52

ROSONE PER CAVI PARALLELI
- PER INSTALLAZIONE SINGOLA
ALIMENTAZIONE INTEGRATA
Per versioni 962mm e 1440mm.
Kit di sospensione e cavo di alimentazione da ordinare a parte.

CODE

105151_.. 01 02 20 21 22**DALI-PUSH**

CODE

105152_.. 01 02 20 21 22

CANOPY FOR PARALLEL CABLES
- FOR SINGLE INSTALLATION
INTEGRATED DRIVER
Suitable for both versions 962mm and 1440mm.
Suspension kit and power cable to be ordered separately.

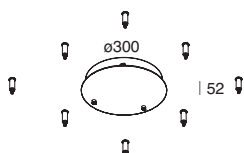

52

ROSONE PER CAVI PARALLELI
- PER INSTALLAZIONE DOPPIA
ALIMENTAZIONE INTEGRATA
Per versioni 962mm e 1440mm.
2 kit sospensione e 2 cavi di alimentazione da ordinare a parte.

CODE

105155_.. 01 02 20 21 22**DALI-PUSH**

CODE

105156_.. 01 02 20 21 22

CANOPY FOR PARALLEL CABLES
- FOR DOUBLE INSTALLATION
INTEGRATED DRIVER
Suitable for both versions 962mm and 1440mm.
Suspension kit and power cable to be ordered separately.

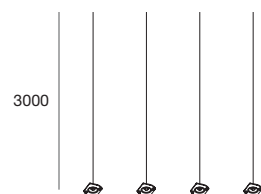

3000

KIT SOSPENSIONE
SUSPENSION KIT

CODE L (mm)

105159.99 3000

3000

CAVO DI ALIMENTAZIONE
Trasparente, bianco o nero.

POWER CABLE
Transparent, white or black.

CODE L (mm)

109001_.. 00 3000

CODE L (mm)

109001_.. 01 02 3000









HALOS SPOT

Novalux dà un valore aggiunto alla famiglia di profili HALOS e crea una linea di anelli luminosi con spot orientabili integrati. Nelle versioni a luce diretta o a luce interna, questo prodotto, di estrema eleganza, unisce l'armonia della luce diffusa circolare alla delicatezza dei faretti, per dare il giusto focus dove necessario.

Novalux gives an added value to the HALOS profile family and creates a line of light rings with integrated adjustable spots. In the direct light or interior light versions, this extremely elegant product combines the harmony of circular diffused light with the delicacy of the spotlights to give the right focus where necessary.

HALOS SPOT EMISSIONE DIRETTA



Profilo LED circolare per installazione a sospensione, ad emissione diretta e completo di 3 proiettori LED orientabili. Doppia accensione per spot ed emissione diretta. Corpo in estruso di alluminio, rosoni in acciaio verniciato a polvere e schermo diffusore in PMMA opale. Proiettori in lega di alluminio pressofuso verniciato, provvisti di riflettore satinato nero in polimero tecnico. 4 cavi di acciaio di sospensione L.3000 mm e di cavo di alimentazione inclusi (4x0,5 mmq per bianco e nero o 4x0,75 mmq trasparente per gli altri colori). Disponibili rosoni con alimentazione integrata per cavi di sospensione convergenti o paralleli, oppure rosoni per alimentazione remota. Alimentazione elettronica 220-240V 50/60Hz disponibile anche dimmerabile DALI-PUSH.

Circular LED profile for suspension mounting, with direct light emission and complete with 3 adjustable LED spotlights. Double switch for spots and direct emission. Body made of extruded aluminium, canopies made of powder coated steel and PMMA opal diffuser. Spotlights made by painted die-cast aluminium alloy, with technical polymer black satin reflector. 4 suspension steel cables L. 3000mm and power cable included (4x0,5 mmq for white and black or 4x0,75 mmq transparent for other colours). Canopies with integrated power supply or for remote power supply are available. Electronic driver 220-240V 50/60Hz are also available DALI-PUSH.

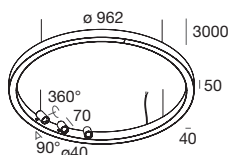
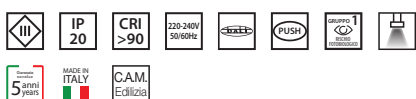

HALOS 962
Emissione diretta + 3 spot
Cavi di sospensione e di alimentazione inclusi.

Direct emission + 3 spots
Suspension and power cables included.

2700K							
BEAM	POWER	CODE	□ FLUX	■ FLUX	■ FLUX	■ FLUX	SPOT FLUX
20°	80W	109701_	01 4643 lm	02 20 21 3947 lm	22 4179 lm		1425 lm
40°	80W	109702_	01 4643 lm	02 20 21 3947 lm	22 4179 lm		1455 lm
3000K							
BEAM	POWER	CODE	□ FLUX	■ FLUX	■ FLUX	■ FLUX	SPOT FLUX
20°	80W	109703_	01 4859 lm	02 20 21 4130 lm	22 4373 lm		1425 lm
40°	80W	109704_	01 4859 lm	02 20 21 4130 lm	22 4373 lm		1455 lm
4000K							
BEAM	POWER	CODE	□ FLUX	■ FLUX	■ FLUX	■ FLUX	SPOT FLUX
20°	80W	109705_	01 5246 lm	02 20 21 4459 lm	22 4721 lm		1581 lm
40°	80W	109706_	01 5246 lm	02 20 21 4459 lm	22 4721 lm		1617 lm

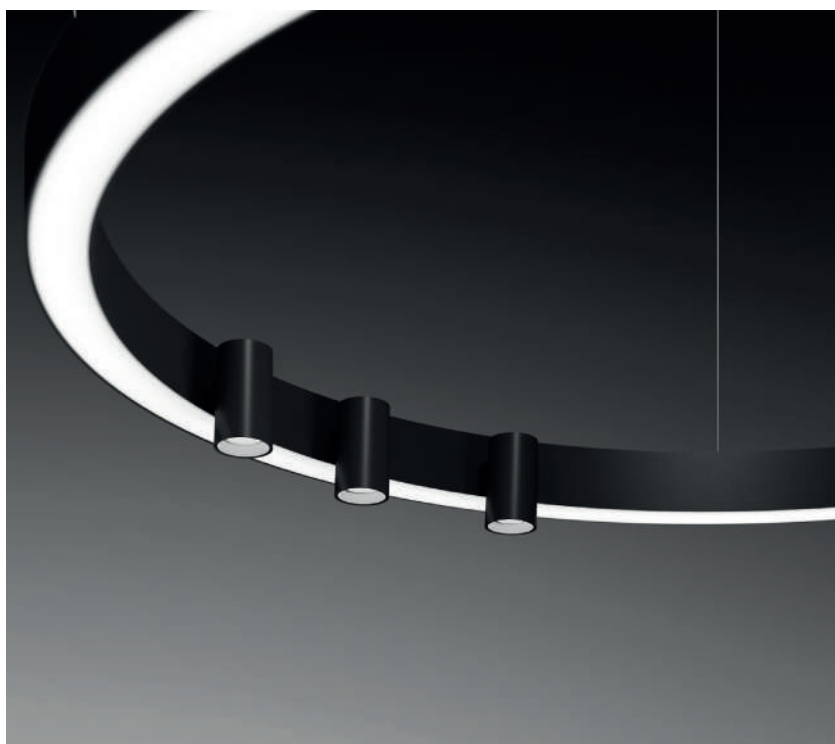

HALOS SPOT**ACCESSORI PER INSTALLAZIONE CON ALIMENTAZIONE REMOTA
ACCESSORIES FOR REMOTE DRIVER MOUNTING**

ROSONE PER INSTALLAZIONE
SINGOLA
ALIMENTAZIONE REMOTA
Alimentatore elettronico da ordinare
a parte.

CODE					
105157...	01	02	20	21	22

CANOPY FOR SINGLE
INSTALLATION
REMOTE DRIVER
Electronic driver to be ordered
separately.

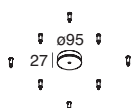

ROSONE PER INSTALLAZIONE
DOPPIA
ALIMENTAZIONE REMOTA
2 alimentatori elettronici da ordinare
a parte.

CODE					
105158...	01	02	20	21	22

CANOPY FOR DOUBLE
INSTALLATION
REMOTE DRIVER
2 electronic drivers to be ordered
separately.

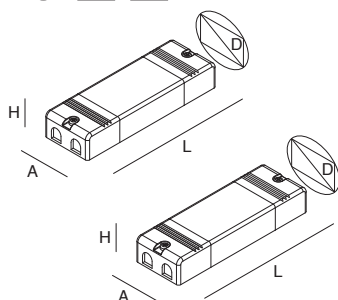

COPPIA DI ALIMENTATORI
ELETTRONICI
220-240V 50/60Hz
Doppia accensione per spot
ed emissione diretta.

CODE	D (mm)	A (mm)	H (mm)	L (mm)
109713.99	105	100	31	235
	77	70	31	200

COUPLE OF ELECTRONIC DRIVERS
220-240V 50/60Hz
Double switch for spots
and direct emission.

DALI-PUSH				
CODE	D (mm)	A (mm)	H (mm)	L (mm)
109714.99	105	100	31	235
	77	70	31	200

HALOS SPOT**ACCESSORI PER INSTALLAZIONE CON ALIMENTAZIONE INTEGRATA
ACCESSORIES FOR INTEGRATED DRIVER MOUNTING**

ROSONE PER CAVI CONVERGENTI
ALIMENTAZIONE INTEGRATA
Prevista accensione unica per
gestione PUSH

CODE					
109715...	01	02	20	21	22

CANOPY FOR CONVERGING
CABLES
INTEGRATED DRIVER
One switch for PUSH management

DALI-PUSH					
CODE					
109716...	01	02	20	21	22

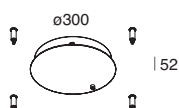

ROSONE PER CAVI PARALLELI
ALIMENTAZIONE INTEGRATA
Prevista accensione unica per
gestione PUSH

CODE					
109717...	01	02	20	21	22

CANOPY FOR PARALLEL CABLES
INTEGRATED DRIVER
One switch for PUSH management

DALI-PUSH					
CODE					
109718...	01	02	20	21	22

HALOS SPOT EMISSIONE INTERNA



Profilo LED circolare per installazione a sospensione, plafone o parete, ad emissione interna e completo di 3 proiettori LED orientabili. Doppia accensione per spot ed emissione interna.
 Corpo in estruso di alluminio e rosoni in acciaio verniciato a polvere, schermo diffusore in PMMA opale. Proiettori in lega di alluminio pressofuso verniciati, provvisti di riflettore satinato nero in polimero tecnico.
 Per installazione a plafone/parete prevedere alimentazione remota da ordinare a parte.
 Per installazione a sospensione prevedere rosoni con alimentazione integrata per cavi di sospensione convergenti o paralleli, oppure rosoni per alimentazione remota unitamente a kit di sospensione e cavo di alimentazione da ordinare a parte.
 Alimentazione elettronica 220-240V 50/60Hz disponibile anche dimmerabile DALI-PUSH.

Circular LED profile for suspension, ceiling or wall mounting, with internal light emission and complete with 3 adjustable LED spotlights. Double switch for spots and internal emission.
 Body made of extruded aluminium, canopies made of powder coated steel and PMMA opal diffuser. Spotlights made by painted die-cast aluminium alloy, with technical polymer black satin reflector.
 For ceiling/wall mounting it is required the remote electronic driver to be ordered separately.
 For suspension mounting it is required the canopy with integrated driver, or remote driver and suspension cables and power cable, to be ordered separately.
 Electronic driver 220-240V 50/60Hz is also available DALI-PUSH.

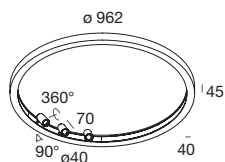

HALOS 962
Emissione interna
+ 3 spot
Internal emission
+ 3 spots

2700K							
BEAM	POWER	CODE	FLUX	FLUX	FLUX	FLUX	SPOT FLUX
20°	70W	109707...	01 2504 lm	02 2021 2128 lm	22 2253 lm		1425 lm
40°	70W	109708...	01 2504 lm	02 2021 2128 lm	22 2253 lm		1455 lm
3000K							
BEAM	POWER	CODE	FLUX	FLUX	FLUX	FLUX	SPOT FLUX
20°	70W	109709...	01 2701 lm	02 2021 2295 lm	22 2430 lm		1425 lm
40°	70W	109710...	01 2701 lm	02 2021 2295 lm	22 2430 lm		1455 lm
4000K							
BEAM	POWER	CODE	FLUX	FLUX	FLUX	FLUX	SPOT FLUX
20°	70W	109711...	01 2785 lm	02 2021 2367 lm	22 2506 lm		1581 lm
40°	70W	109712...	01 2785 lm	02 2021 2367 lm	22 2506 lm		1617 lm



HALOS SPOT**ACCESSORI PER INSTALLAZIONE A SOSPENSIONE/PLAFONE/PARETE CON ALIMENTAZIONE REMOTA**
ACCESSORIES FOR SUSPENSION/CEILING/WALL MOUNTING WITH REMOTE DRIVER

ROSONE PER INSTALLAZIONE SINGOLA
ALIMENTAZIONE REMOTA
Kit di sospensione, cavo di alimentazione ed
alimentatore elettronico da ordinare a parte.

CANOPY FOR SINGLE INSTALLATION
REMOTE DRIVER
Suspension kit, power cable and electronic
driver to be ordered separately.

CODE

105157... 01 02 20 21 22



ROSONE PER INSTALLAZIONE DOPPIA
ALIMENTAZIONE REMOTA
2 kit di sospensione, 2 cavi di alimentazione e
2 alimentatori elettronici da ordinare a parte.

CANOPY FOR DOUBLE INSTALLATION
REMOTE DRIVER
2 Suspension kits, 2 power cables and
2 electronic drivers to be ordered separately.

CODE

105158... 01 02 20 21 22

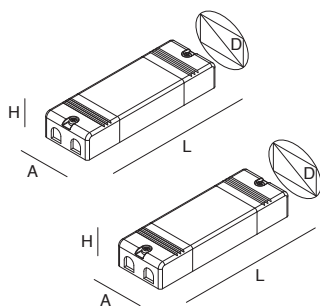

COPPIA DI ALIMENTATORI ELETTRONICI
220-240V 50/60Hz
Doppia accensione per spot
ed emissione interna.

COUPLE OF ELECTRONIC DRIVERS
220-240V 50/60Hz
Double switch for spots
and internal emission.

CODE D (mm) A (mm) H (mm) L (mm)

109713.99 105 100 31 235
77 70 31 200

DALI-PUSH

CODE D (mm) A (mm) H (mm) L (mm)

109714.99 105 100 31 235
77 70 31 200

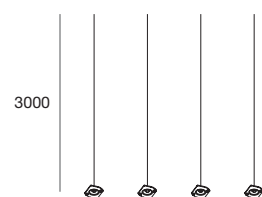

KIT SOSPENSIONE
SUSPENSION KIT

CODE L (mm)

105159.99 3000



CAVO DI ALIMENTAZIONE
Trasparente, bianco o nero.

POWER CABLE
Transparent, white or black.

CODE L (mm)

109002... 00 3000

CODE L (mm)

109002... 01 02 3000

HALOS SPOT

ACCESSORI PER INSTALLAZIONE A SOSPENSIONE CON ALIMENTAZIONE INTEGRATA ACCESSORIES FOR SUSPENSION MOUNTING WITH INTEGRATED DRIVER



52

ROSONE PER CAVI CONVERGENTI
ALIMENTAZIONE INTEGRATA
Kit sospensione e cavo di alimentazione
da ordinare a parte
Prevista accensione unica per gestione PUSH

CANOPY FOR CONVERGING CABLES
INTEGRATED DRIVER
Suspension kit, power cable driver to be
ordered separately.
One switch for PUSH management

CODE					
109715_..	01	02	20	21	22

DALI-PUSH

CODE					
109716_..	01	02	20	21	22

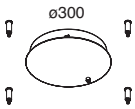

52

ROSONE PER CAVI PARALLELI
ALIMENTAZIONE INTEGRATA
Prevista accensione unica per gestione PUSH
Kit sospensione e cavo di alimentazione da
ordinare a parte

CANOPY FOR PARALLEL CABLES
INTEGRATED DRIVER
Suspension kit, power cable driver to be
ordered separately.
One switch for PUSH management

CODE					
109717_..	01	02	20	21	22

DALI-PUSH

CODE					
109718_..	01	02	20	21	22

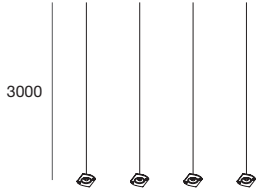

3000

KIT SOSPENSIONE
SUSPENSION KIT

CODE	L (mm)
105159.99	3000



3000

CAVO DI ALIMENTAZIONE
Trasparente, bianco o nero.
POWER CABLE
Transparent, white or black.

CODE		L (mm)
109002_..	00	3000

CODE			L (mm)
109002_..	01	02	3000

